

Q20-2 Polarized Retroreflective Sensors with Visible Red LED



Features

Universal rectangular housing ideal for global manufacturing with best-in-class optical to mechanical alignment (patent pending).



- Polarized retroreflective photoelectric sensor in a compact, rugged, sealed plastic housing
- Standard 3 mm threaded mounting holes on 25.4 mm (1 in) spacing
- Polarized retroreflective models for one-sided installation with a retroreflective target are ideal for detecting dark and shiny targets
- Best-in-class optical to mechanical alignment for consistent lock & load mounting with visible red LEDs for simple and precise alignment

WARNING:



- **Do not use this device for personnel protection**
- Using this device for personnel protection could result in serious injury or death.
- This device does not include the self-checking redundant circuitry necessary to allow its use in personnel safety applications. A device failure or malfunction can cause either an energized (on) or de-energized (off) output condition.

Models

Sensing Mode	Models	Sensing Range	Connection	Output Type	Operating Mode
Polarized Retroreflective	Q20-2PLP-2M	5000 mm (196.9 in) using BRT 92x92C reflector	2 m (6.5 ft) unterminated 3-wire PVC-jacketed cable	PNP	LO/DO selectable via switch
	Q20-2NLP-2M			NPN	
Visible red, 645 nm	Q20-2VPLP-2M		2 m (6.5 ft) unterminated 4-wire PVC-jacketed cable	PNP	Complementary
	Q20-2VNLP-2M			NPN	

For other configurations, contact Banner Engineering. To order models with a 150 mm (6 in) PVC-jacketed cable and a 3-pin M8 male quick disconnect (3-wire models), replace "2M" with "Q3". To order models with a 150 mm (6 in) PVC-jacketed cable and a 4-pin M8 male quick disconnect (3-wire models), replace "2M" with "Q". To order models with a 150 mm (6 in) PVC-jacketed cable and a 4-pin M12 male quick disconnect (3- or 4-wire models), replace "2M" with "Q5".

Overview

The Q20-2 polarized retroreflective sensors offer excellent sensing performance in a compact plastic housing that is easily integrated into tight spaces.

Threaded brass inserts provide stable mounting points, and the bright indicators provide user feedback of the sensor status. The single-turn gain potentiometer, LO/DO switch, and bright indicator LEDs provide easy alignment and configuration for reliable sensing.

1. Green: Power Indicator
2. Amber: Light Sensed Indicator (flashes for marginal conditions)
3. Single-turn Gain Potentiometer (some models)
4. Light Operate/Dark Operate Switch (some models)

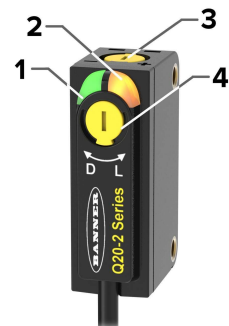

Mount the Device

1. If a bracket is needed, mount the device onto the bracket.
2. Mount the device (or the device and the bracket) to the machine or equipment at the desired location. Do not tighten the mounting screws at this time.
3. Check the device alignment.
4. Tighten the mounting screws to secure the device (or the device and the bracket) in the aligned position.



Q20-2 Wiring

Cabled wiring diagrams are shown. Quick disconnect wiring diagrams are functionally identical.

CAUTION: Observe proper ESD precautions (grounding) when connecting quick disconnect models.

<p>PNP Models with Switchable Operating Mode Default mode: Dark Operate</p>	<p>NPN Models with Switchable Operating Mode Default mode: Dark Operate</p>	
<p>Complementary Models, PNP Output</p>	<p>Complementary Models, NPN Output</p>	<p>1 = Brown 2 = White 3 = Blue 4 = Black</p>
<p>3-pin M8 Male Quick Disconnect</p>	<p>4-pin M8 Male Quick Disconnect</p>	<p>4-pin M12 Male Quick Disconnect</p>

In dark operate (DO) mode, the output is ON when the target returns less light to the sensor than the configured target and OFF when the sensor detects more light than the configured/taught target.

In light operate (LO) mode, the output is ON when the target returns the same or more light to the sensor and OFF when the sensor detects less light than the configured/taught target.

In **retroreflective** sensing modes, light operate is active when the beam is unblocked and dark operate is active when the beam is blocked.

Specifications

Supply Voltage

10 V DC to 30 V DC (10% maximum ripple within specified limits) at less than 20 mA, exclusive of load

Sensing Beam

Visible red LED, 645 nm

Supply Protection Circuitry

Protected against reverse polarity and transient voltages

Output Configuration

Single output type (PNP or NPN), light operate (LO), dark operate (DO), or complementary (one light operate and one dark operate), depending on model

Rating: 100 mA total output current

Off-state leakage current: < 10 µA at 30 V DC

ON-state saturation voltage: PNP: < 3 V at 100 mA; NPN: < 3 V at 100 mA

Protected against output short-circuit, continuous overload, and false pulse on power-up

Output Response

600 µs, OFF to ON and ON to OFF

Repeatability

144 µs

Indicators

- Two LED indicators on sensor top:
- Green solid: Power on
- Amber solid: Light sensed
- Amber flashing: Marginal sensing condition

Construction

ABS housing, acrylic lens cover; PVC cable, PBT gain adjuster, PBT LO/DO switch

Connections

2 m (6.5 ft) unterminated 3-wire PVC-jacketed cable, 150 mm (6 in) PVC-jacketed cable with a 3-pin M8 male quick-disconnect connector, or 150 mm (6 in) PVC-jacketed cable with a 4-pin M12 male quick-disconnect connector, depending on model.

Environmental Rating

IP67

Operating Conditions

Temperature: -25 °C to +70 °C (-13 °F to +158 °F)
 95% at +70 °C maximum relative humidity (non-condensing)

Certifications

 Banner Engineering BV
 Park Lane, Culliganlaan 2F bus 3
 1831 Diegem, BELGIUM

 Turck Banner LTD Blenheim House
 Blenheim Court
 Wickford, Essex SS11 8YT
 GREAT BRITAIN

 **Industrial Control Equipment**
LISTED 3TJJ

Required Overcurrent Protection



WARNING: Electrical connections must be made by qualified personnel in accordance with local and national electrical codes and regulations.

Overcurrent protection is required to be provided by end product application per the supplied table.

Overcurrent protection may be provided with external fusing or via Current Limiting, Class 2 Power Supply.

Supply wiring leads < 24 AWG shall not be spliced.

For additional product support, go to www.bannerengineering.com.

Supply Wiring (AWG)	Required Overcurrent Protection (A)	Supply Wiring (AWG)	Required Overcurrent Protection (A)
20	5.0	26	1.0
22	3.0	28	0.8
24	1.0	30	0.5

FCC Part 15 Class B for Unintentional Radiators

(Part 15.105(b)) This equipment has been tested and found to comply with the limits for a Class B digital device, pursuant to part 15 of the FCC Rules. These limits are designed to provide reasonable protection against harmful interference in a residential installation. This equipment generates, uses, and can radiate radio frequency energy and, if not installed and used in accordance with the instructions, may cause harmful interference to radio communications. However, there is no guarantee that interference will not occur in a particular installation. If this equipment does cause harmful interference to radio or television reception, which can be determined by turning the equipment off and on, the user is encouraged to try to correct the interference by one or more of the following measures:

- Reorient or relocate the receiving antenna.
- Increase the separation between the equipment and receiver.
- Connect the equipment into an outlet on a circuit different from that to which the receiver is connected.
- Consult the dealer or an experienced radio/TV technician for help.

(Part 15.21) Any changes or modifications not expressly approved by the party responsible for compliance could void the user's authority to operate this equipment.

Industry Canada ICES-003(B)

This device complies with CAN ICES-3 (B)/NMB-3(B). Operation is subject to the following two conditions: 1) This device may not cause harmful interference; and 2) This device must accept any interference received, including interference that may cause undesired operation.

Cet appareil est conforme à la norme NMB-3(B). Le fonctionnement est soumis aux deux conditions suivantes : (1) ce dispositif ne peut pas occasionner d'interférences, et (2) il doit tolérer toute interférence, y compris celles susceptibles de provoquer un fonctionnement non souhaité du dispositif.

Dimensions

All measurements are listed in millimeters [inches], unless noted otherwise. The measurements provided are subject to change.

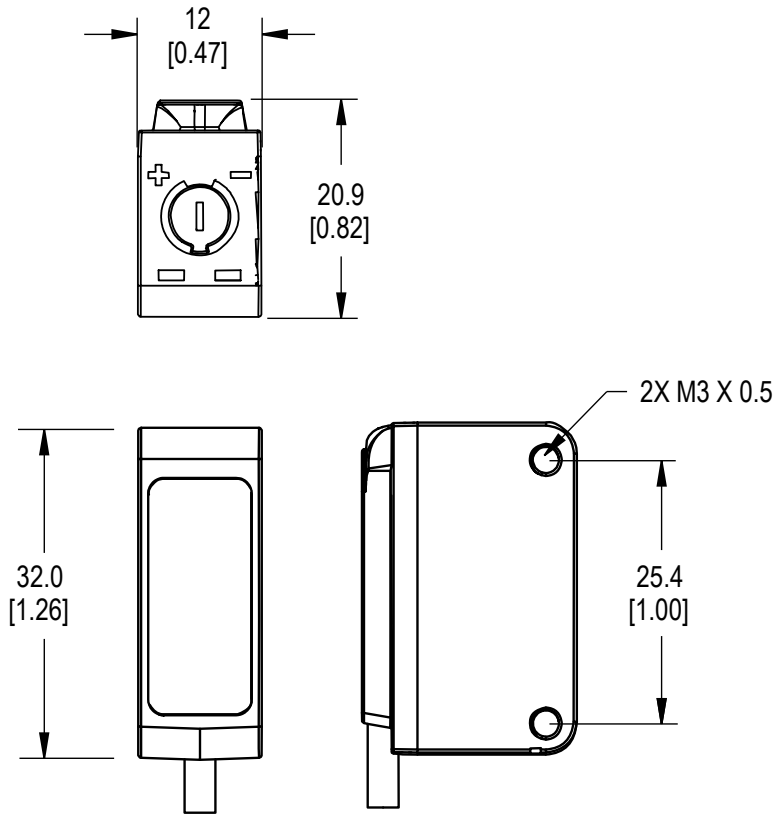

Maximum mounting screw torque: 0.56 Nm (5 in-lbs)

Two M3 screws (12 mm) and washers are included.

Performance Curves

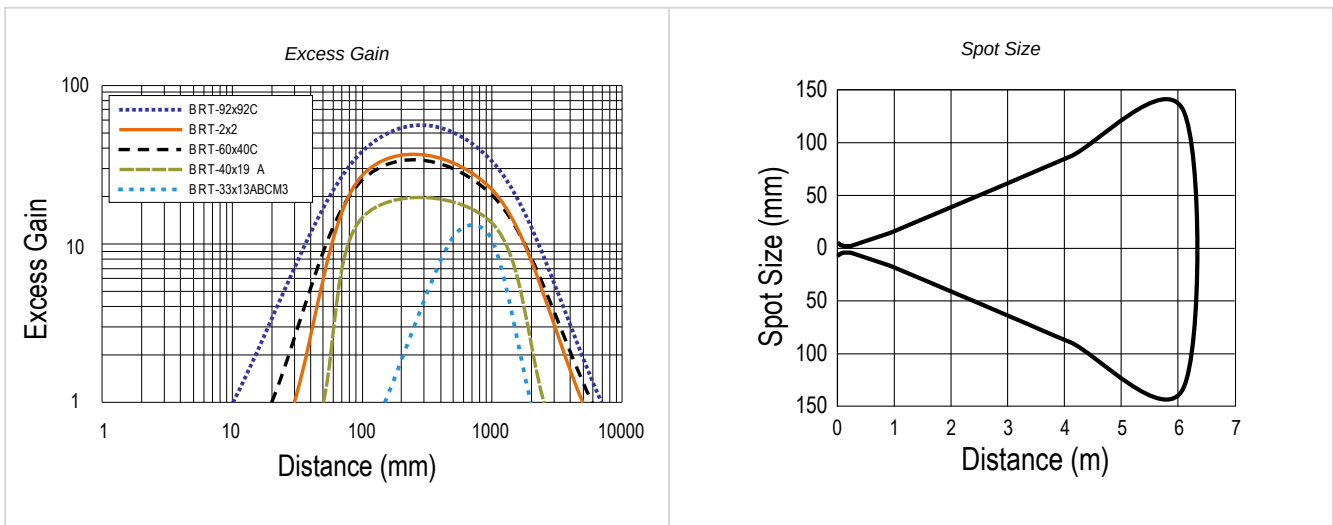

Accessories

Cordsets

3-pin Threaded M8 Cordsets—Single Ended				
Model	Length	Style	Dimensions	Pinout (Female)
PKG3M-2	2.035 m (6.68 ft)	Straight		<p>1 = Brown 3 = Blue 4 = Black</p>
PKG3M-5	5.035 m (16.51 ft)			
PKG3M-7	7.035 m (23.08 ft)			
PKG3M-9	9.035 m (29.64 ft)			
PKG3M-10	10.035 m (32.92 ft)			
PKW3M-2	2 m (6.56 ft)	Right-Angle		<p>1 = Brown 3 = Blue 4 = Black</p>
PKW3M-5	5 m (16.40 ft)			
PKW3M-9	9 m (29.53 ft)			

4-Pin Threaded M12 Cordsets—Single Ended				
Model	Length	Style	Dimensions	Pinout (Female)
MQDC-406	2 m (6.56 ft)	Straight		
MQDC-415	5 m (16.4 ft)			
MQDC-430	9 m (29.5 ft)			
MQDC-450	15 m (49.2 ft)			
MQDC-406RA	2 m (6.56 ft)	Right-Angle		<p>1 = Brown 2 = White 3 = Blue 4 = Black 5 = Unused</p>
MQDC-415RA	5 m (16.4 ft)			
MQDC-430RA	9 m (29.5 ft)			
MQDC-450RA	15 m (49.2 ft)			

Mounting Brackets

<p>SMBQ20L</p> <ul style="list-style-type: none"> • Sensor vertical base mount • ±5° tip, ±7° swivel • Stainless steel 	
--	--

<p>SMBQ20LV</p> <ul style="list-style-type: none"> • Sensor vertical back mount • ±10° tip • Stainless steel 	
--	--

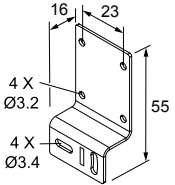
<p>SMBQ20H</p> <ul style="list-style-type: none"> • Sensor horizontal flange mount • ±10° swivel • Stainless steel 	
--	---

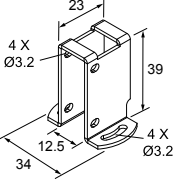
<p>SMBQ20U</p> <ul style="list-style-type: none"> • Sensor vertical base mount with protection • ±22.5° swivel • Stainless steel 	
--	---

Reflectors

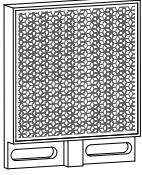
<p>BRT-2X2</p> <ul style="list-style-type: none"> • Square, acrylic target • Reflectivity factor: 1.0 • Max. temperature: +50 °C (+122 °F) • Optional brackets are available • Approximate size: 51 mm × 51 mm 	
--	---

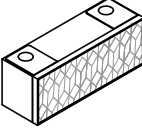
<p>BRT-33X13ABCM3</p> <ul style="list-style-type: none"> • Rectangular, acrylic target • Reflectivity Factor: 1.3 • Temperature: • Optional brackets are available • Approximate size: 33 mm × 13 mm • Threaded M3 mounting holes 	
--	---

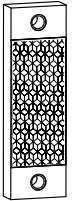
<p>BRT-40X19A</p> <ul style="list-style-type: none"> • Rectangular, acrylic target • Reflectivity Factor: 1.3 • Temperature: • Approximate size: 19 mm × 60 mm overall; 19 mm × 40 mm reflector 	
--	---

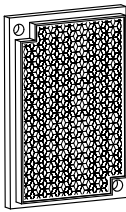
<p>BRT-60X40C</p> <ul style="list-style-type: none"> • Rectangular, acrylic target • Reflectivity Factor: 1.4 • Temperature: • Optional brackets are available • Approximate size: 40 mm × 60 mm 	
--	---

BRT-92X92C

- Square, acrylic target
- Reflectivity Factor: 3.0
- Temperature:
- Optional brackets are available
- Approximate size: 92 mm × 92 mm



Retroreflective Tape

Model	Reflectivity Factor	Maximum Temperature	Size
BRT-THG-2-100	0.7	+60 °C (+140 °F)	50 mm (2 in) wide, 2.5 m (100 in) long

Banner Engineering Corp Limited Warranty

Banner Engineering Corp. warrants its products to be free from defects in material and workmanship for one year following the date of shipment. Banner Engineering Corp. will repair or replace, free of charge, any product of its manufacture which, at the time it is returned to the factory, is found to have been defective during the warranty period. This warranty does not cover damage or liability for misuse, abuse, or the improper application or installation of the Banner product.

THIS LIMITED WARRANTY IS EXCLUSIVE AND IN LIEU OF ALL OTHER WARRANTIES WHETHER EXPRESS OR IMPLIED (INCLUDING, WITHOUT LIMITATION, ANY WARRANTY OF MERCHANTABILITY OR FITNESS FOR A PARTICULAR PURPOSE), AND WHETHER ARISING UNDER COURSE OF PERFORMANCE, COURSE OF DEALING OR TRADE USAGE.

This Warranty is exclusive and limited to repair or, at the discretion of Banner Engineering Corp., replacement. **IN NO EVENT SHALL BANNER ENGINEERING CORP. BE LIABLE TO BUYER OR ANY OTHER PERSON OR ENTITY FOR ANY EXTRA COSTS, EXPENSES, LOSSES, LOSS OF PROFITS, OR ANY INCIDENTAL, CONSEQUENTIAL OR SPECIAL DAMAGES RESULTING FROM ANY PRODUCT DEFECT OR FROM THE USE OR INABILITY TO USE THE PRODUCT, WHETHER ARISING IN CONTRACT OR WARRANTY, STATUTE, TORT, STRICT LIABILITY, NEGLIGENCE, OR OTHERWISE.**

Banner Engineering Corp. reserves the right to change, modify or improve the design of the product without assuming any obligations or liabilities relating to any product previously manufactured by Banner Engineering Corp. Any misuse, abuse, or improper application or installation of this product or use of the product for personal protection applications when the product is identified as not intended for such purposes will void the product warranty. Any modifications to this product without prior express approval by Banner Engineering Corp will void the product warranties. All specifications published in this document are subject to change; Banner reserves the right to modify product specifications or update documentation at any time. Specifications and product information in English supersede that which is provided in any other language. For the most recent version of any documentation, refer to: www.bannerengineering.com.

For patent information, see www.bannerengineering.com/patents.