

BI10U-M18-IOL6X2-H1141

Inductive Sensor – IO-Link Communication and Configuration

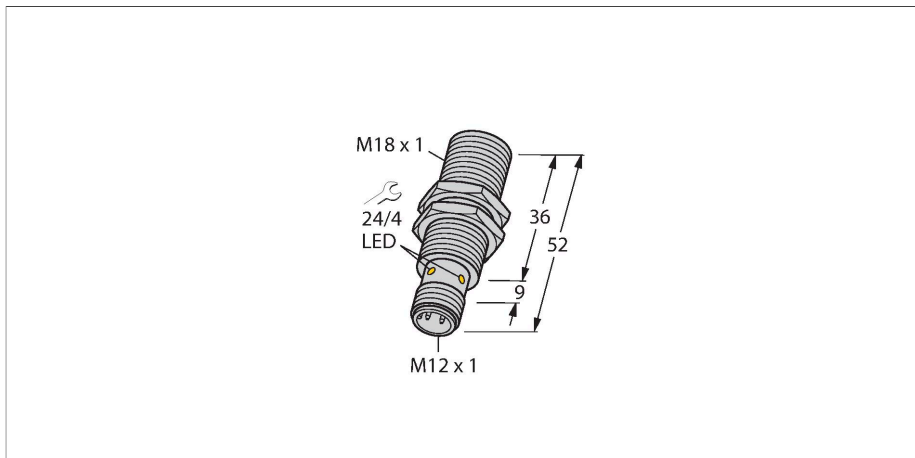

Technical data

Type	BI10U-M18-IOL6X2-H1141
ID	1644875
General data	
Rated switching distance	10 mm
Mounting conditions	Flush
Secured operating distance	$\leq (0.81 \times S_n)$ mm
Repeat accuracy	≤ 2 % of full scale
Temperature drift	$\leq \pm 10$ %
Hysteresis	3...15 %
Electrical data	
Operating voltage U_B	10...30 VDC
Ripple U_{ss}	≤ 10 % U_{Bmax}
DC rated operating current I_o	≤ 150 mA
No-load current	≤ 27 mA
Residual current	≤ 0.1 mA
Isolation test voltage	0.5 kV
Short-circuit protection	yes/Cyclic
Voltage drop at I_o	≤ 1.8 V
Wire break/reverse polarity protection	yes/Complete
Communication protocol	IO-Link
Output function	4-wire, NO/NC, PNP/NPN
Output 1	Switching output or IO-Link mode
Output 2	Switching output
DC field stability	300 mT
AC field stability	300 mT _{ss}
Switching frequency	0.5 kHz

Features

- Threaded barrel, M18 x 1
- Chrome-plated brass
- Factor 1 for all metals
- Protection class IP68
- Resistant to magnetic fields
- Large switching distance
- DC 4-wire, 10...30 VDC
- M12 x 1 connector
- Configuration and communication via IO-Link v1.1 or via standard I/O
- Electrical outputs independently configurable
- Switching distance can be parametrized per output and hysteresis
- Identification via 32-byte memory
- Temperature monitoring with adjustable limits
- Various timer and pulse monitoring functions

Wiring diagram

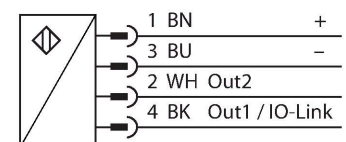

Functional principle

Inductive sensors are designed for wear-free and contactless detection of metal objects. uprox3 sensors have significant advantages due to their patented multi-coil system. They excel thanks to their optimum switching distances, maximum flexibility and operational reliability as well as efficient standardization. In addition, the uprox3 IO-Link sensors allow certain parameters to be set within predefined limits and various device functions to be configured in accordance with

customer needs, using an IO-Link Master. For detailed information, refer to the uprox3 IO-Link manual.

Technical data

IO-Link	
IO-Link specification	V 1.1
IO-Link port type	Class A
Communication mode	COM 2 (38.4 kBaud)
Process data width	16 bit
Switchpoint information	2 bit
Status bit information	3 bit
Frame type	2.2
Minimum cycle time	8 ms
Function pin 4	IO-Link
Function Pin 2	DI
Maximum cable length	20 m
Included in the SIDI GSDML	Yes
Mechanical data	
Design	Threaded barrel, M18 x 1
Dimensions	52 mm
Housing material	Metal, CuZn, Chrome-plated
Active area material	Plastic, LCP
Max. tightening torque of housing nut	25 Nm
Electrical connection	Connector, M12 × 1
Environmental conditions	
Ambient temperature	-25...+70 °C
Vibration resistance	55 Hz (1 mm)
Shock resistance	30 g (11 ms)
Protection class	IP68
MTTF	874 years acc. to SN 29500 (Ed. 99) 40 °C
Power-on indication	LED, Green
Switching state	LED, Yellow

Mounting instructions

Mounting instructions/Description

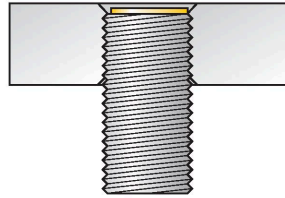
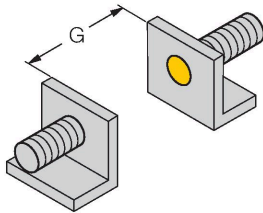
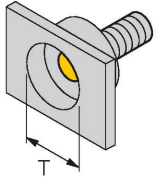

Distance D 36 mm

Distance W 3 x Sn

Distance T 3 x B

Distance S 1.5 x B

Distance G 6 x Sn

Diameter active area B \varnothing 18 mm

All flush mountable uprox+ threaded barrel types are also recessed mountable. Safe operation is ensured if the sensor is screwed in by half a turn.

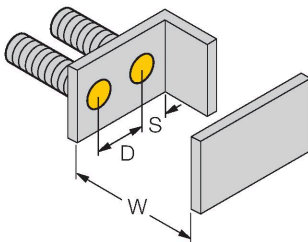

Accessories

BST-18B

6947214

Mounting clamp for threaded barrel sensors, with dead-stop; material: PA6

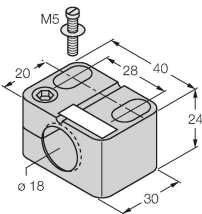

MW18

6945004

Mounting bracket for threaded barrel sensors; material: Stainless steel A2 1.4301 (AISI 304)

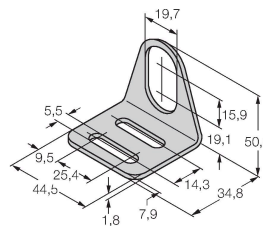

BSS-18

6901320

Mounting clamp for smooth and threaded barrel sensors; material: Polypropylene

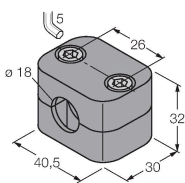

Accessories

Dimension drawing	Type	ID	
	RKC4.4T-2/TEL	6625013	Connection cable, M12 female connector, straight, 4-pin, cable length: 2 m, jacket material: PVC, black; cULus approval



Accessories

Dimension drawing	Type	ID	
	USB-2-IOL-0002	6825482	IO-Link Master with integrated USB port

