

NI30U-EM30WD-AP6X-H1141/3GD

Inductive Sensor – For the Food Industry

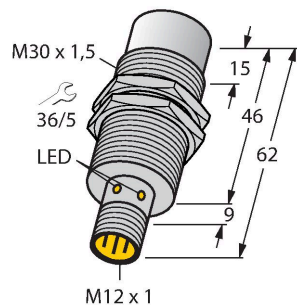

Features

- Threaded barrel, M30 x 1.5
- Stainless steel, 1.4404
- Front cap made of liquid crystal polymer
- Factor 1 for all metals
- Resistant to magnetic fields
- For temperatures of -40 °C...+100 °C
- High protection class IP69K for harsh environments
- Special double-lip seal
- Protection against all common acidic and alkaline cleaning agents
- Laser engraved label, permanently legible
- DC 3-wire, 10...30 VDC
- NO contact, PNP output
- M12 x 1 male connector
- ATEX category II 3 G, Ex zone 2
- ATEX category II 3 D, Ex zone 22

Technical data

Type	NI30U-EM30WD-AP6X-H1141/3GD
ID	1634861
General data	
Rated switching distance	30 mm
Mounting conditions	Non-flush
Secured operating distance	$\leq (0.81 \times S_n)$ mm
Repeat accuracy	$\leq 2\%$ of full scale
Temperature drift	$\leq \pm 10\%$ $\leq \pm 20\%$, $\leq -25\text{ °C}$, $\geq +70\text{ °C}$
Hysteresis	3...15 %
Electrical data	
Operating voltage U_b	10...30 VDC
Ripple U_{ss}	$\leq 10\%$ U_{Bmax}
DC rated operating current I_o	≤ 200 mA
No-load current	≤ 25 mA
Residual current	≤ 0.1 mA
Isolation test voltage	0.5 kV
Short-circuit protection	yes/Cyclic
Voltage drop at I_o	≤ 1.8 V
Wire break/reverse polarity protection	yes/Complete
Output function	3-wire, NO contact, PNP
DC field stability	300 mT
AC field stability	300 mT _{ss}
Insulation class	□
Switching frequency	1 kHz
Approval acc. to	ATEX test certificate TURCK Ex-10002M X

Wiring diagram

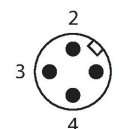
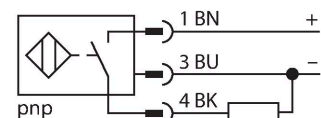

Functional principle

The inductive sensors for the food industry are absolutely tight and resistant to cleaning agents and disinfectants. The requirements of the protection classes IP68 and IP69K are well exceeded by our uprox®+ sensors. The sensors are entirely protected by the LCP front cap and the stainless steel housing.

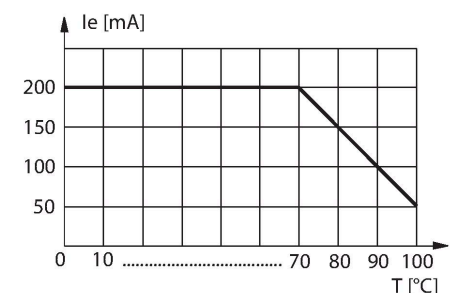

Technical data

Device marking	EX II 3 G Ex ec IIC T4 Gc/II 3 D Ex tc IIIC T110 °C Dc
Warning	Do not unplug connector under voltage
Mechanical data	
Design	Threaded barrel, M30 x 1.5
Dimensions	62 mm
Housing material	Stainless steel, 1.4404 (AISI 316L)
Active area material	Plastic, LCP
Connector housing	plastic, PP
Admissible pressure on front cap	≤ 10 bar
Max. tightening torque of housing nut	75 Nm
Electrical connection	Connector, M12 × 1
Environmental conditions	
Ambient temperature	-40...+100 °C
	For explosion hazardous areas see instruction leaflet
Vibration resistance	55 Hz (1 mm)
Shock resistance	30 g (11 ms)
Protection class	IP68 IP69K
MTTF	874 years acc. to SN 29500 (Ed. 99) 40 °C
Switching state	LED, Yellow
Included in delivery	SC-M12/3GD

Mounting instructions

Mounting instructions/Description

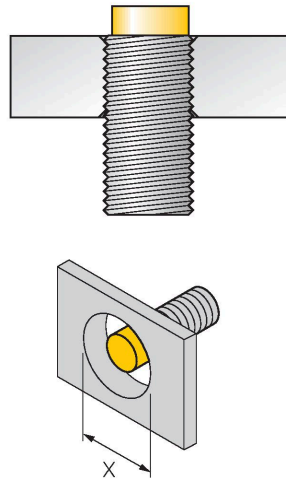
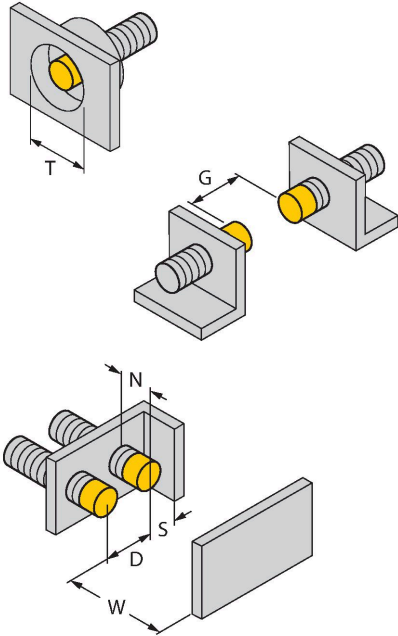

Distance D	135 mm
Distance W	3 x Sn
Distance T	3 x B
Distance S	1.5 x B
Distance G	6 x Sn
Distance N	2 x Sn
Diameter active area B	Ø 30 mm

All non-flush mountable aprox®+ threaded barrel sensors can be screwed to the upper edge of the barrel. In this mounting position, the sensor operates safely with a 20 % reduced switching distance.

When installed in an aperture plate, a distance of X = 140 mm must be observed.

Accessories

MW30

6945005

Mounting bracket for threaded barrel sensors; material: Stainless steel A2 1.4301 (AISI 304)

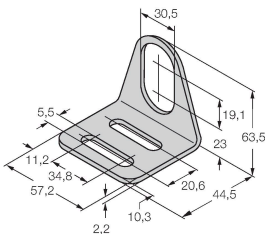

BSS-30

6901319

Mounting clamp for smooth and threaded barrel sensors; material: Polypropylene

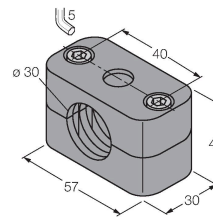

Accessories

Dimension drawing

Type

ID

RKH4-2/TFE

6935482

Connection cable, M12 female connector, straight, 3-pin, stainless steel coupling nut, cable length: 2 m, jacket material: PVC, gray; temperature range: -25...+80 °C

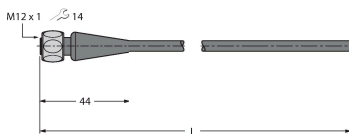

Dimension drawing

Type
RKH4-2/TFGID
6934384

Connection cable, M12 female connector, straight, 3-pin, stainless steel coupling nut, cable length: 2 m, jacket material: TPE, gray; temperature range: -40...+105 °C

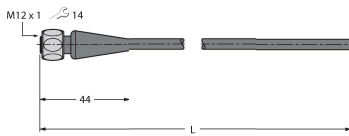

Instructions for use

Intended use	This device fulfills the directive 2014/34/EU and is suited for use in explosion-hazardous areas acc. to EN60079-0:2018, EN60079-7:2015/A1:2018, EN60079-31:2014. In order to ensure correct operation to the intended purpose it is required to observe the national regulations and directives.
For use in explosion hazardous areas conform to classification	II 3 G and II 3 D (Group II, Category 3 G, electrical equipment for gaseous atmospheres and category 3 D, electrical equipment for dust atmospheres).
Marking (see device or technical data sheet)	⊕ II 3 G Ex ec IIC T4 Gc acc. to EN 60079-0:2018 and EN 60079-7:2015/A1:2018 and ⊕ II 3 D Ex tc IIIC T110 °C Dc acc. to EN 60079-0:2018 and EN 60079-31:2014
Local admissible ambient temperature	-25...+70 °C
Installation/Commissioning	These devices may only be installed, connected and operated by trained and qualified staff. Qualified staff must have knowledge of protection classes, directives and regulations concerning electrical equipment designed for use in explosion hazardous areas. Please verify that the classification and the marking on the device comply with the actual application conditions.
Installation and mounting instructions	Avoid static charging of cables and plastic devices. Please only clean the device with a damp cloth. Do not install the device in a dust flow and avoid build-up of dust deposits on the device. The devices must be protected against strong magnetic fields. The pin configuration and the electrical specifications can be taken from the device marking or the technical data sheet. In order to avoid contamination of the device, please remove possible blanking plugs of the cable glands or connectors only shortly before inserting the cable or opening the cable socket.
Special conditions for safe operation	For devices with M12 connectors please use the supplied safety clip SC-M12/3GD. Do not disconnect the plug-in connection or cable under voltage. Please attach a warning label permanently in an appropriate fashion in close proximity to the plug-in connection with the following inscription: Nicht unter Spannung trennen / Do not separate when energized. The device must be protected against any kind of mechanical damage and degrading UV-radiation. The IP protection rating of the connectors is given only in combination with a suitable O-ring. Load voltage and operating voltage of this equipment must be supplied from power supplies with safe isolation (IEC 30364/UL508), to ensure that the rated voltage of the equipment (24 VDC +20% = 28.8 VDC) is never exceeded by more than 40%.
Service/Maintenance	Repairs are not possible. The approval expires if the device is repaired or modified by a person other than the manufacturer. The most important data from the approval are listed.